



Compliance Certified
EBWA Challenge Test 2007



FMax

The Evolution Of Watercoolers

1. Introduction

The FMax is the world's most complete watercooler, with a stylish and modern design, it will blend seamlessly into any location, and the unit can be further customised with any one of 8 changeable side panels.

Featuring all the latest Ebac technology such as our patented Cassette WaterTrail™ for sanitisation in less than 60 seconds, our Leak Prevention Manifold, which means that pinholes in

bottles never cause leaks, and our Vacuum Insulated Hot Tank can save customers over £30 per cooler each year on running costs.

Building on Ebac's reputation as the leading watercooler manufacturer, the FMax is the Evolution of Watercoolers.

Contents

1. FMax Introduction

2. WaterTrail

- Sanitise 40% More Coolers
- 100% Sanitisation

3. Hot Tank

- Unrivalled Energy Efficiency
- High Burst Rate

4. Good Looks That Last

- Robust Construction
- Changeable Panels

5. Product Features

- No Leak Manifold
- Duplex Dispense Nozzle
- Temperature Combinations
- Watertrail™ for 100% Sanitisation
- Patented Label Splitter
- Drip Tray Evaporation
- High Dispense Point
- Integrated Wheels

6. Technical Specification Comparison

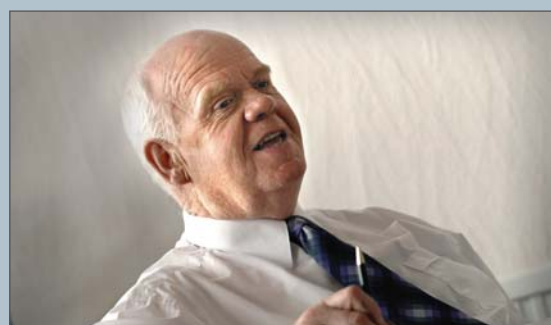

“The FMax is our most technologically advanced watercooler yet - it combines cutting edge innovation with stylish good looks and the proven quality of Ebac watercoolers”

John Elliott MBE, Chairman, Ebac Group Ltd

2. WaterTrail™

Developed in 1994, the WaterTrail™ is now the most popular method of sanitisation in Europe. All water contact parts are simply replaced - not cleaned - meaning 100% sanitisation takes a matter of just seconds.

The WaterTrail™ saves you both time and money as more coolers can be sanitised per day, and staff do not need complex training.

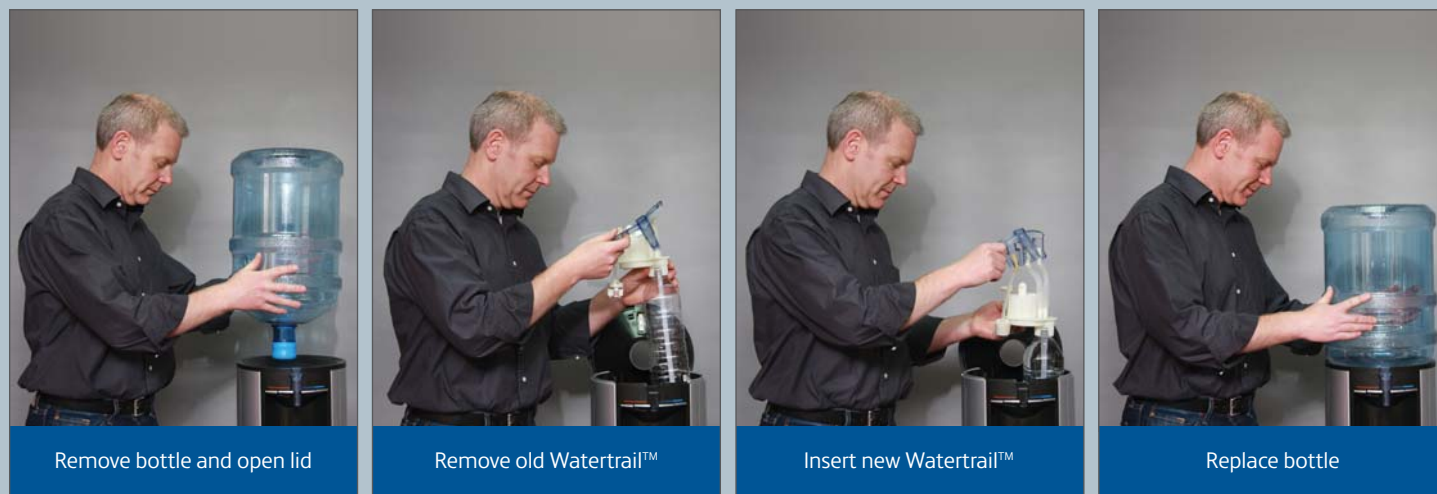

Sanitise 40% More Coolers Per Day

Unlike sanitisation, which requires time consuming processes that don't always result in a fully cleaned and disinfected watercooler, the WaterTrail™ can be easily changed, even by a child, in less than 60 seconds. Normal methods of sanitisation take between 20 minutes (On-site Chemical) and 5 minutes (Steam) (see Fig 1.1). Not only do these methods take longer, but they are also considerably more complex (with a greater margin for error) and require extensive staff training and rigorous quality control systems.

With the WaterTrail™, the old unit is removed from the cooler, and the new one is inserted into place as shown in the images above.

Now available in Cassette format for our FMax Watercooler, this means it's easy for staff to do it right first time, every time - with minimal training and minimum increase in his or her normal duties.

Fig 1.1 Sanitisation Method Time Comparisons

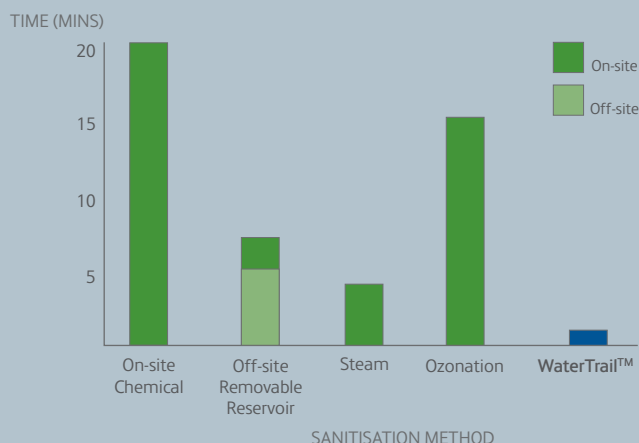

100% Sanitisation

Our removable WaterTrail™ replaces all water contact parts, and is the only system available to offer true 100% sanitisation every time.

Steam cleaning and Ozonation methods of sanitisation do not clean the watercooler - they only disinfect it - although they do kill the bacteria, they do not remove the biofilm. Therefore these methods do not comply with BWCA regulations which state that the cooler must be cleaned, not just disinfected - making coolers based on these methods of sanitisation non-compliant with the BWCA.

The WaterTrail™ is fully compliant with the BWCA as all water contact parts are replaced.

Traditional reservoirs also have an additional risk, as the way they are designed means a pocket of air sits above the water (see Fig 1.2). This creates more favourable conditions for bacterial growth when compared to the WaterTrail™ in which water does not come into contact with air at all.

Fig 1.2 Traditional Reservoir Air Contact

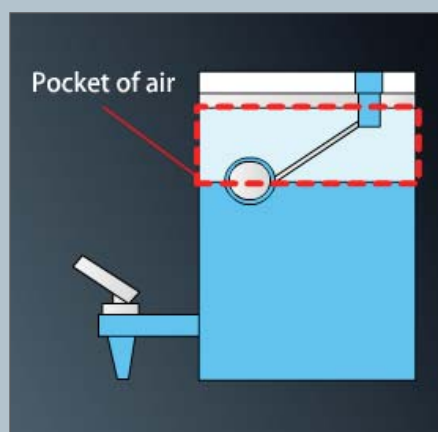

3. Hot Tank

Our Energy Efficient Hot Tank was the winner of the 2007 Cooler & Vending Awards 'Best Sustainability Initiative' and the Silver Award Winner for the EBWA 'Best Environmental Initiative' award.

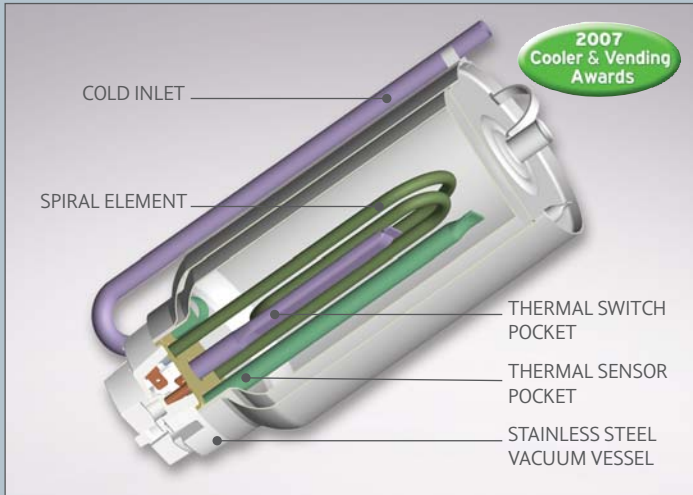

During busy periods at a watercooler, customers need the peace of mind to know that their cooler can dispense enough consecutive cold water, and our FMax has an extra large PET reservoir which can dispense up to 14 consecutive cups of cold water.



Unrivalled Energy Efficiency

Energy Efficiency is becoming of increasing importance to watercooler customers - in a recent study we found that 76% of facility managers would be 'much more likely' to purchase a unit that was more energy efficient than competitors.

Unlike competitor models, our industry award winning Hot Tank in our FMax works like a vacuum flask and features an extra layer of insulation to ensure than it retains its heat - it is therefore heated less frequently, and as a result is 30 times more energy efficient than other Hot Tanks.

Customers will save around £32 / €40 per cooler each year on running costs - so a medium size business with 5 coolers will save over £150 / €190 each year. As well as financial savings, customers will also be reducing their Carbon Footprint - an increasingly important fact.

Fig 1.3 Hot Tank Energy Consumption

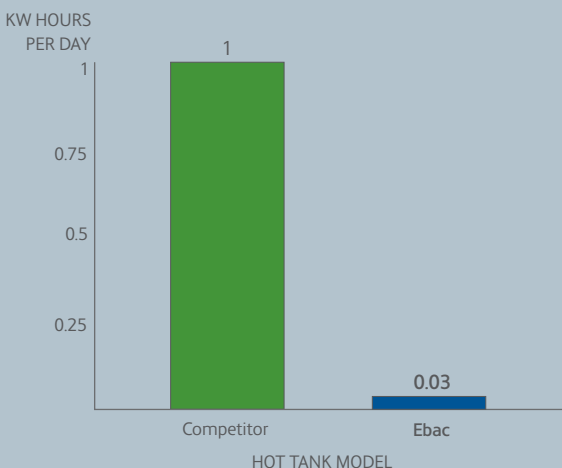

High Burst Rate

Research has shown that during peak demand times such as lunch breaks a Watercooler can have as many as 8 cups of cold water dispensed consecutively. With many competitor coolers this would result in some people receiving un-chilled water - which can cause dissatisfaction and discourages customers from drinking from the cooler.

The FMax features an extra large 2.5 litre reservoir - which will dispense up to 14 cups of cold water consecutively - this ensures that during busy periods there is sufficient cold water available and customers are not supplied with un-chilled water - increasing customer satisfaction and encouraging them to drink more water.

Fig 1.4 Consecutive Cups Of Chilled Water

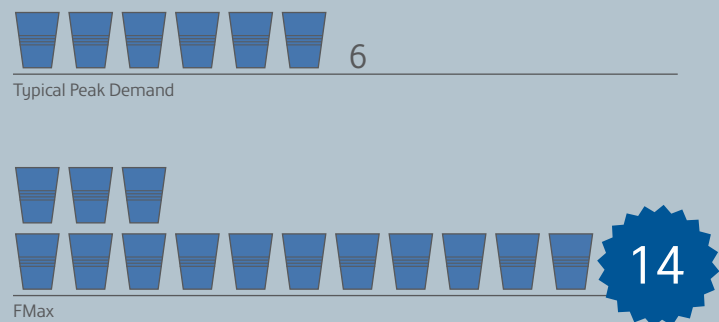

14



4. Good Looks That Last

Combining good looks with impeccable reliability – the FMax features stylish curves to fit into the modern office environment and is constructed from ultra-durable ABS polymer to ensure it withstands many years of use and keeps repair and replacement costs down.



Robust Construction

Customers are increasingly demanding a water cooler that fits in with their modern office, and the FMax is the perfect cooler to meet their requirements. During construction we use 3 or 4 times more material than we need to at weak points to ensure the water cooler withstands years and years of constant use.

Designed to be stylish, modern and practical - the FMax is built from ultra durable ABS Polymer. This exceptional durability - four chassis can support the weight of a vehicle - means that the cooler will take what ever your worst customer throws at it - it will never rust, and will therefore save you time and money in repair and replacement costs.

To offer your customer maximum choice and reduce the costs associated with cooler damage, the FMax is available with a selection of 8 different side panels.



Changeable Panels

The FMax also features a choice of 8 changeable side panels, meaning you can win more customers by offering a customised cooler to suit their own office.

You will also save money on replacements as damaged panels can be easily interchanged without having to replace the entire cooler.

The FMax is available in the following colours:

- Silver
- Dark Blue
- Green
- Cream
- Red
- White
- Black
- Light Blue

Fig 1.5 The FMax's changeable side panels. The FMax is also available with a black body.





5. Product Features

The FMax is our most technologically advanced watercooler - as well as featuring our Patented WaterTrail™ & award-winning Hot Tank, it has a number of other unique features that you will only find in an Ebac Watercooler.

No Leak Manifold

Ensures that drips from the bottle cap do not contaminate the water reservoir or cause leaks.

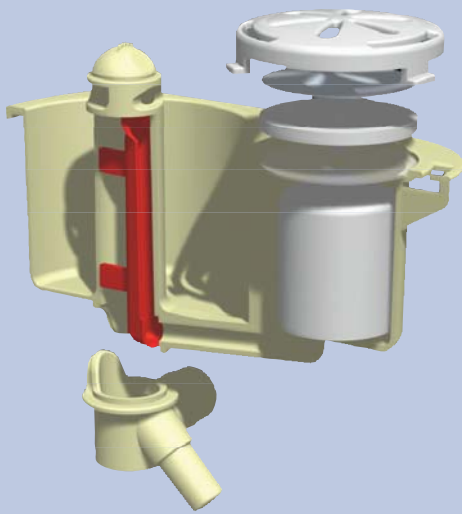

Duplex Dispense Nozzle

Prevents contamination, customers fingers and hands can never come into direct contact with the point of water dispense.

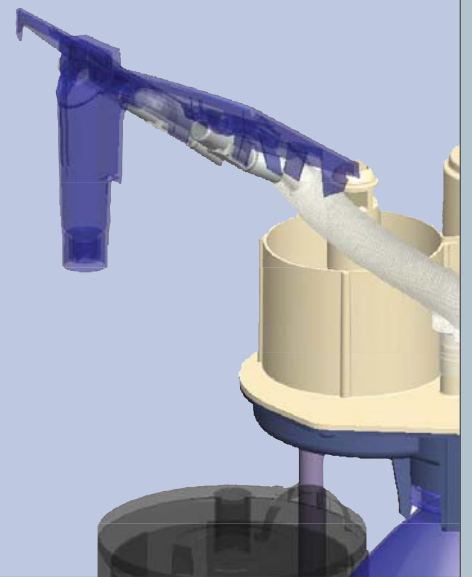

Temperature Combinations

3 solid metal dispense levers offering a choice of Cold, Ambient or Hot water.

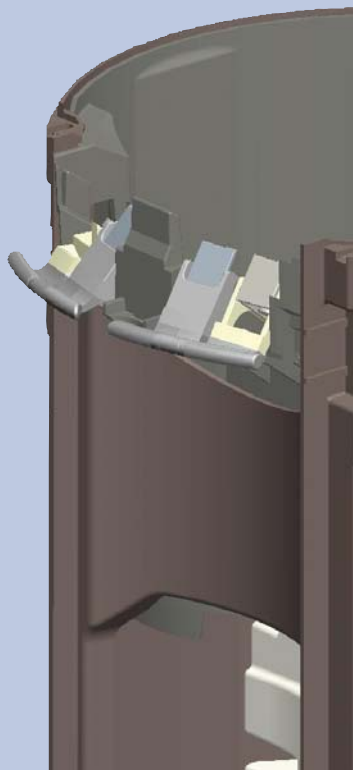

WaterTrail™ for 100% Sanitisation

Using our patented WaterTrail™ system, all water contact parts are simply replaced, not cleaned - meaning you have 100% sanitisation in a matter of seconds.



Patented Label Splitter

With our Hedgehog Spike the water bottle label is pierced but never dislodged - this ensures that labels are never pushed up into the bottle.

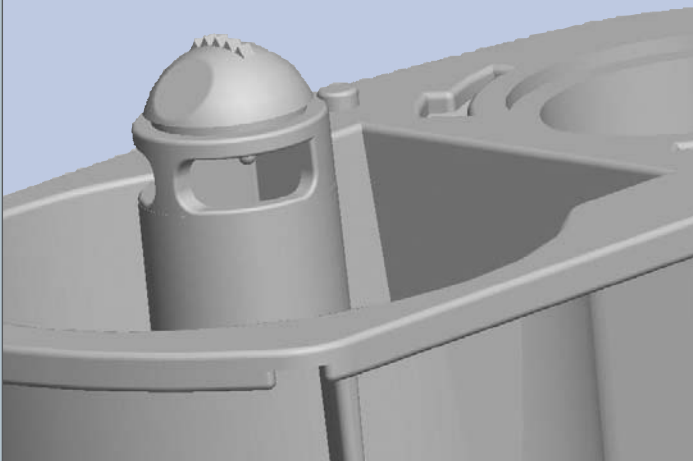

Drip Tray Evaporation

Drips from the dispense nozzle are taken to a reservoir located on the compressor at the base of the cooler - and harmlessly evaporates due to the natural heat generated by the compressor.

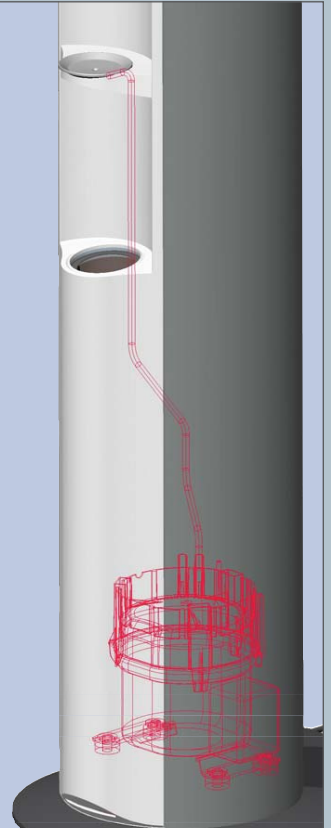

High Dispense Point

Customers have easier access to water with our High Level Dispense Point - no stooping or bending is required to dispense water.

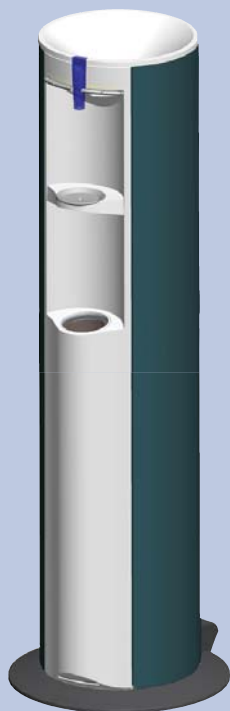

Integrated Wheels

Means that the FMax can easily be transported from one location to another safely, and with no heavy lifting required.

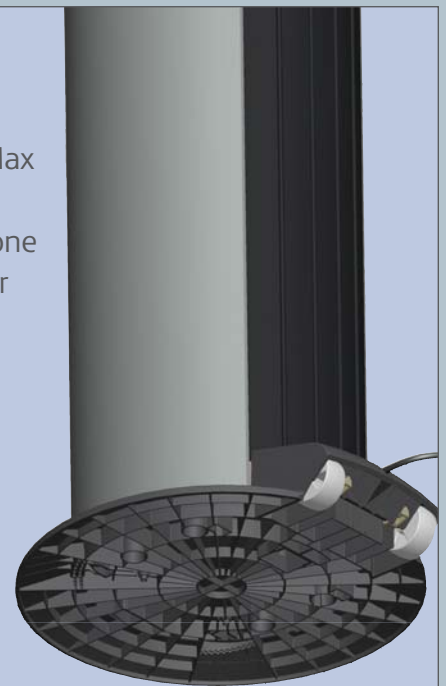

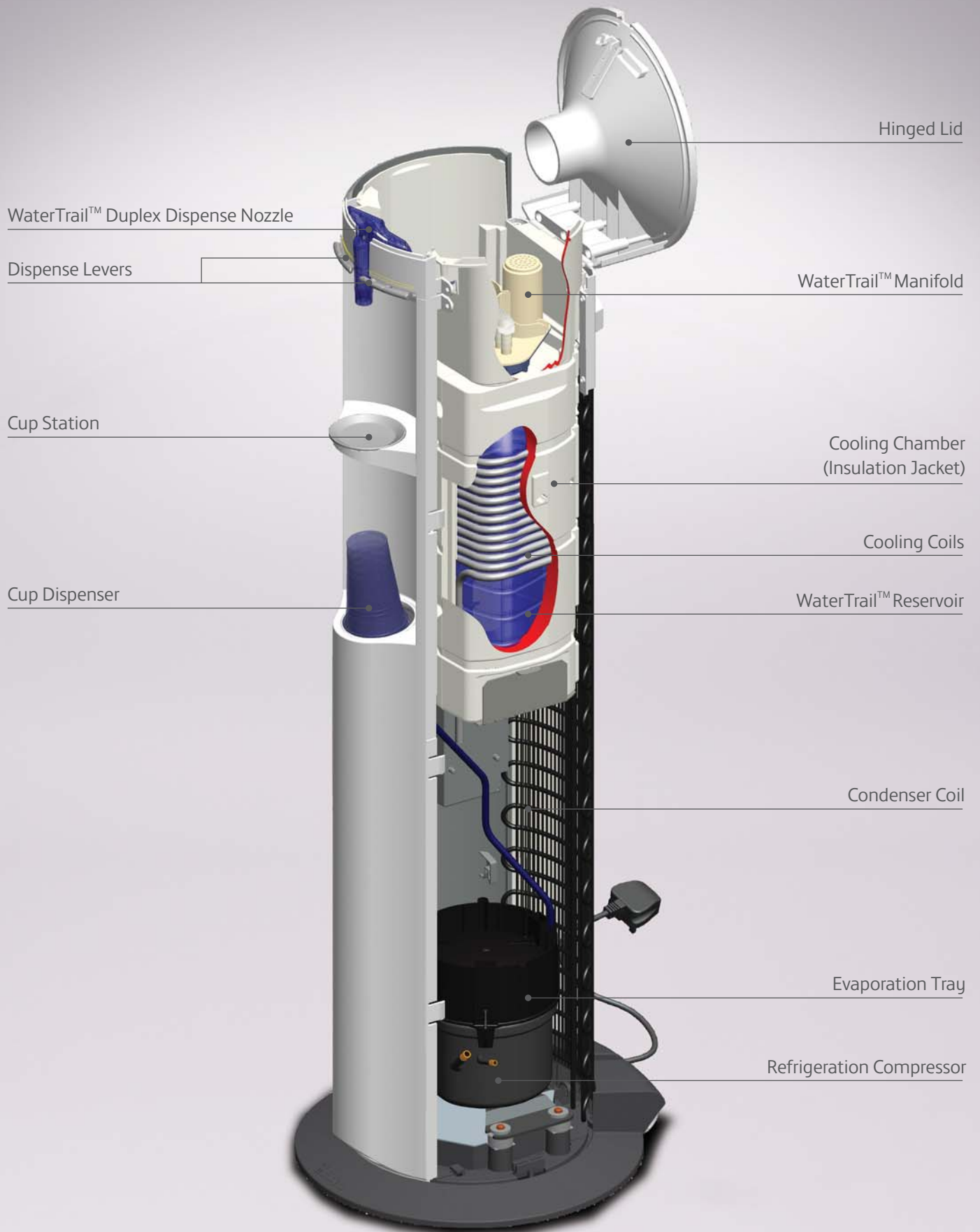

6. Technical Specification Comparison

The following table compares all Ebac Watercooler models to help you understand the differences and similarities between each cooler.

	SlimCool Filter	SlimCool Bottled	EMax	EMax POU	FMax	FMax POU
Specifications						
Height (cm)	95.5	95.5	100	100	110	112
Width (cm)	20	20	33	33	26	26
Depth (cm)	20	20	33	33	39	39
Weight (kg)	13	13	17.5	17.5	20	23
Approvals - CE, CB	✓	✓	✓	✓	✓	CE
Refrigeration Type	Electronic	Electronic	R134A	R134A	R134A	R134A
Air Filtration (Microns)	-	0.5	0.5	0.5	0.5	-
Water Filter Type	Brita Maxtra	-	-	Carbon block	-	Carbon block
Water Filter Life (weeks)	4	-	-	26	-	26
Hot Tank Energy Consumption (standby) (KW/day)	-	-	0.03	0.03	0.03	0.03
Hot Water Temperature (°C)	-	-	86°C / 94°C	86°C / 94°C	86°C / 94°C	86°C / 94°C
Hot Tank Heat Up Time (minutes)	-	-	15	15	15	15
Sanitisation Features						
WaterTrail™ Sanitisation System	✓	✓	✓	✓	✓	-
Cassette WaterTrail™ Sanitisation System	✓	✓	-	-	✓	-
Duplex Dispense Nozzle	✓	✓	-	-	✓	✓
Direct Dispense System	-	-	-	-	-	✓
Functional Features						
Adjustable Drip Tray	✓	✓	-	-	-	-
Drip Tray Evaporation	-	-	-	-	✓	✓
Built In Wheels	-	-	✓	✓	✓	✓
Integrated Cup Dispenser	-	-	✓	✓	✓	✓
Height Adjustable Feet	-	-	✓	✓	-	-
Quick Change Side Panels	✓	✓	-	-	✓	✓
High Dispense Point	✓	✓	-	-	✓	✓
Hedgehog Spike	-	✓	✓	-	✓	-
Additional Features						
Burst Rate (no. of consecutive chilled cups)	12	12	10	10	14	20
Hot Tank Burst Rate (no. of consecutive hot cups)	-	-	6	6	6	6
No Leak Manifold	-	✓	✓	-	✓	-
ABS Polymer Body	✓	✓	✓	✓	✓	✓



Ebac Limited, St Helen Trading Estate, Bishop Auckland, County Durham, DL14 9AL

Tel: 01388 605061 ext. 424 or 432 Email: watercooler@ebac.com
www.ebacwatercoolers.com

Details are correct at time of going to press. All specifications and features are subject to change at Ebac's discretion.